

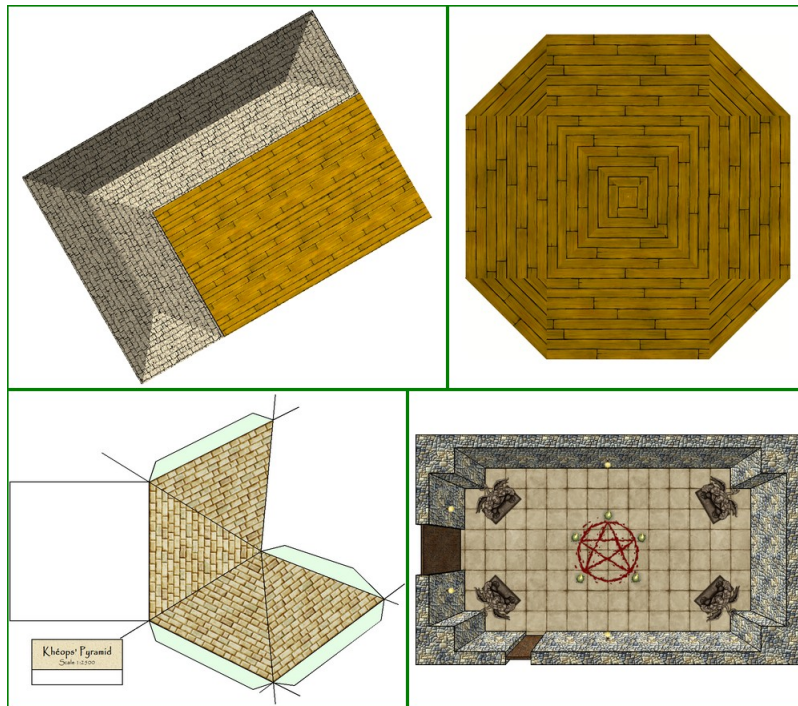

# Shaded Polygons: Shaded Roofs, Rotated Fill Styles and Perspective...



## A Campaign Cartographer 3/3+ Article



### Credits

Text, layout, maps and methods by Joachim de Ravenbel.  
Proofreading and technical advice by KenG.

### Conventions

In CC3 and CC3+, many tools have an icon button on one of the toolbars around the main screen. All the icons will be displayed in pairs with the CC3 picture followed by the new CC3+ version, for example the *Polygon* tool:  . All the features of this article are the same regardless of your version.





## Introduction

Shaded polygons come from a tool designed to shade roofs relatively to their slopes and their orientations to sun azimuth and elevation. You can also use them to:

- rotate a fill style
- create top down perspectives as explained in [this tutorial](#).

## 1. Shaded polygons and slope

When you consider a basic roof made of two sloped rectangles, it makes sense that the slope facing the sun is lighter than the opposite slope. When one side is not directly facing the sun, both slopes have different shadings.

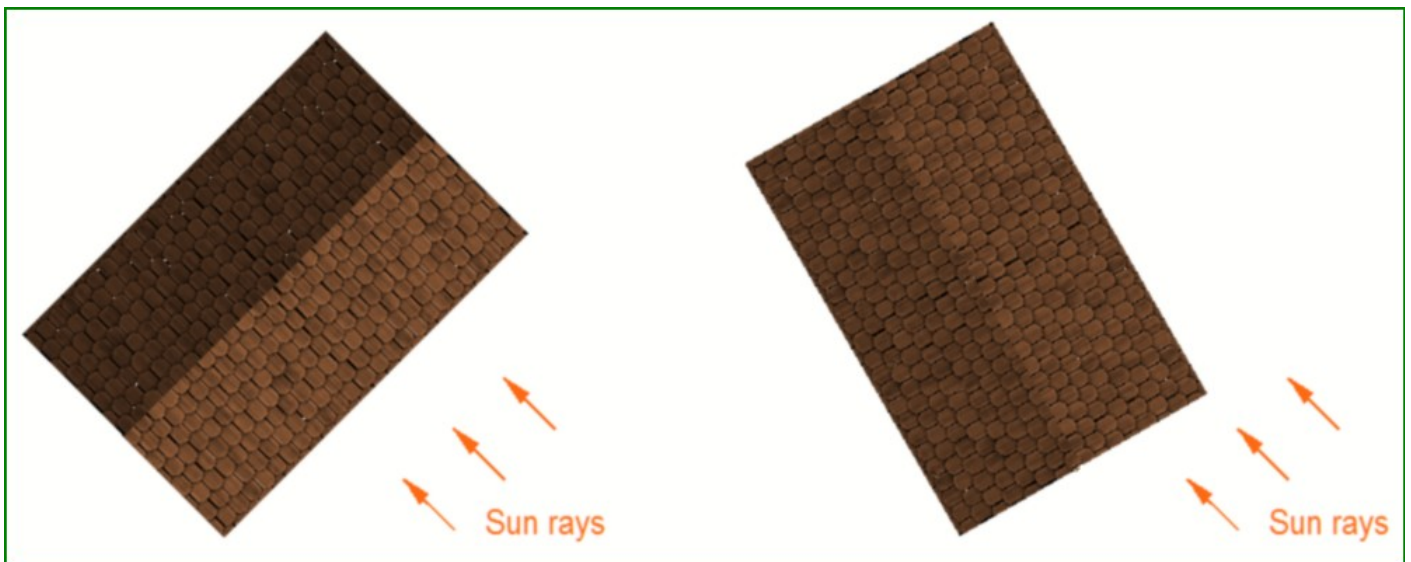

Left: one of the roof side's is facing the sun rays and is light. The opposite side is much darker. Right: no side is directly facing the sun so the contrast is less pronounced.

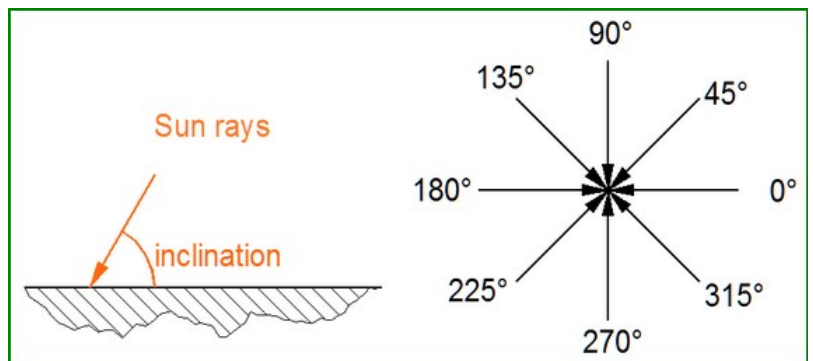

When you start a CC3 map, the default settings for the sun is an azimuth of 315°, meaning that the sun comes from the north-east, and an inclination of 60°, meaning that the sun rays make an angle of 60° relative to the horizontal.

For the azimuth, an angle of 0° means from the east, while 90°, 180° and 270° respectively mean from the North, West and South (assuming north is facing the top of the map).







You can change these values by using the **Global Sun** command available by right-clicking either on the **Sheet and effects** icon  or the **Display Speed Settings** icon . Alternatively type **SUNINFO** in the command line followed by a carriage return. Once the changes have been made, click on the **OK** button.

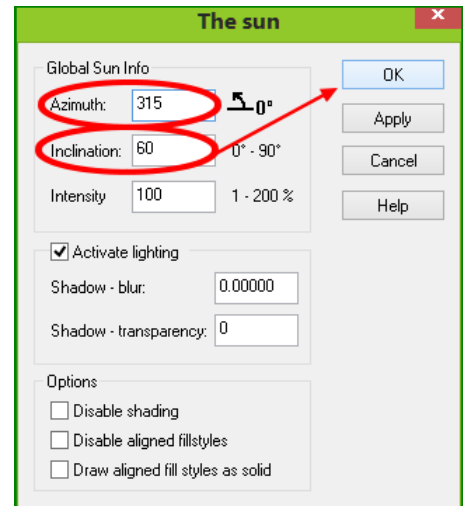

When you create a shaded polygon, you need two parameters:

- the **angle** corresponds to the angle in degrees made by the polygon's slope direction, from bottom to top, relative to the east. It follows the same rule as the azimuth:

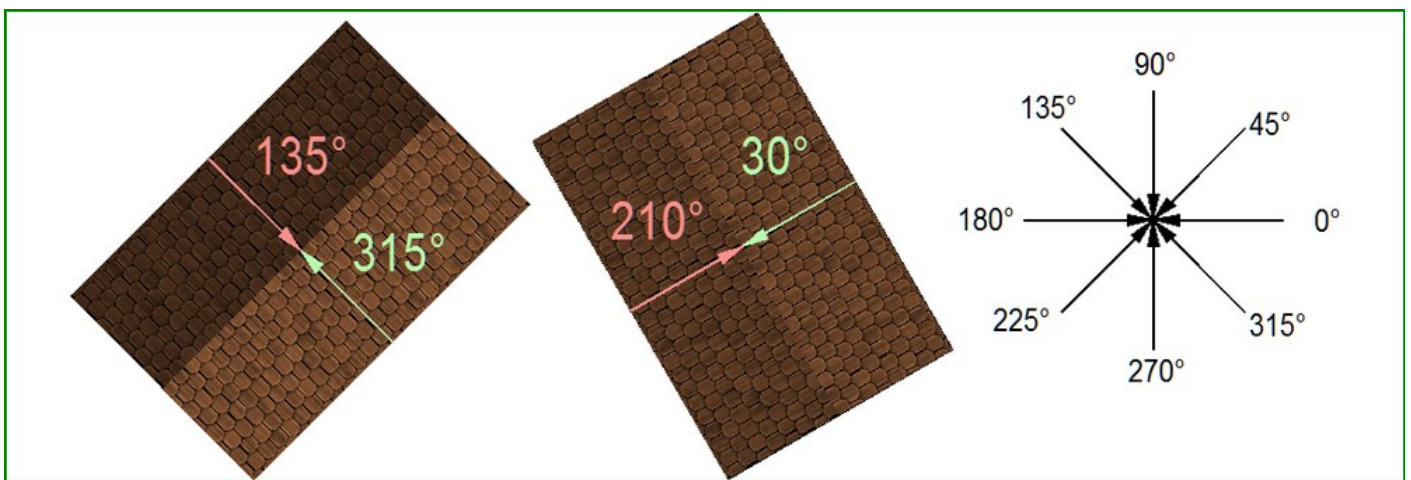

- the **pitch** is also an angle in degrees<sup>1</sup>, made by the polygon relative to the horizontal ground. A pitch of 0° means a flat horizontal shape, while a pitch of 90° would be a vertical entity. Common sloped roofs have pitch angles ranging from 10° to 70°, with an average near 45°:

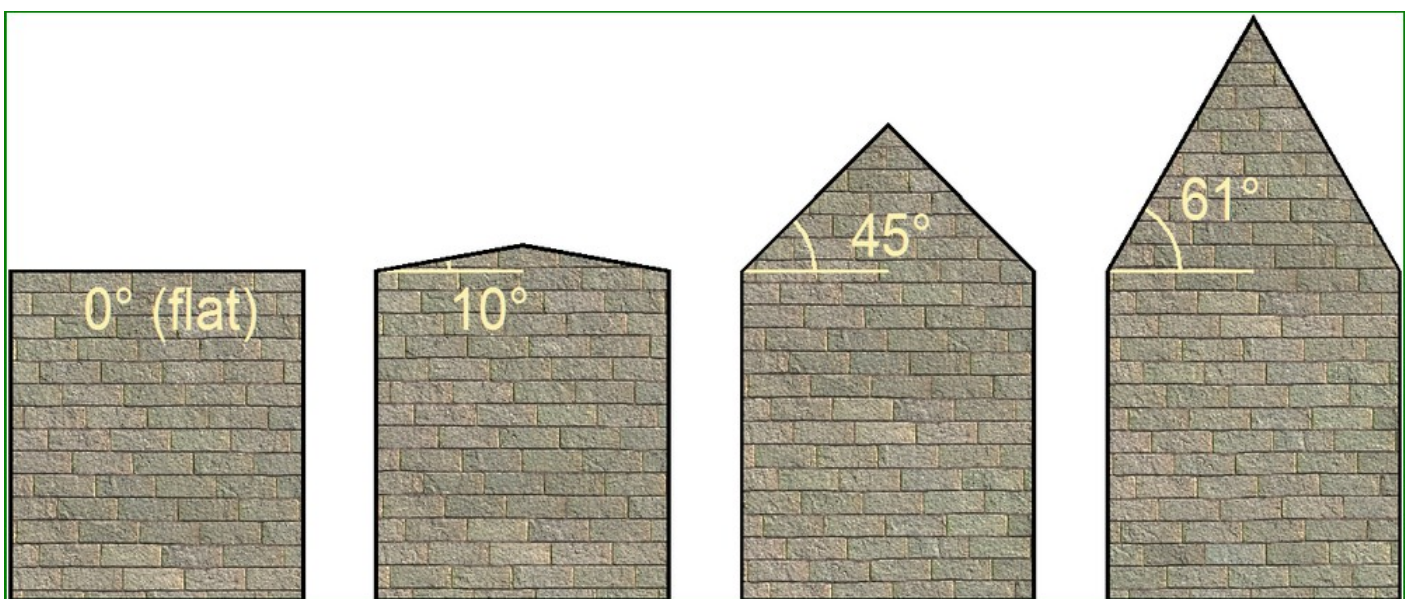

<sup>1</sup> In builder's terminology, the **roof pitch** is often the tangent of this angle.

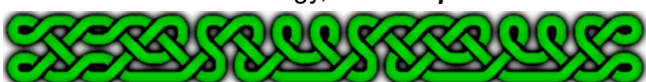



The higher the pitch angle, the more contrast you get between the light and the dark sides:

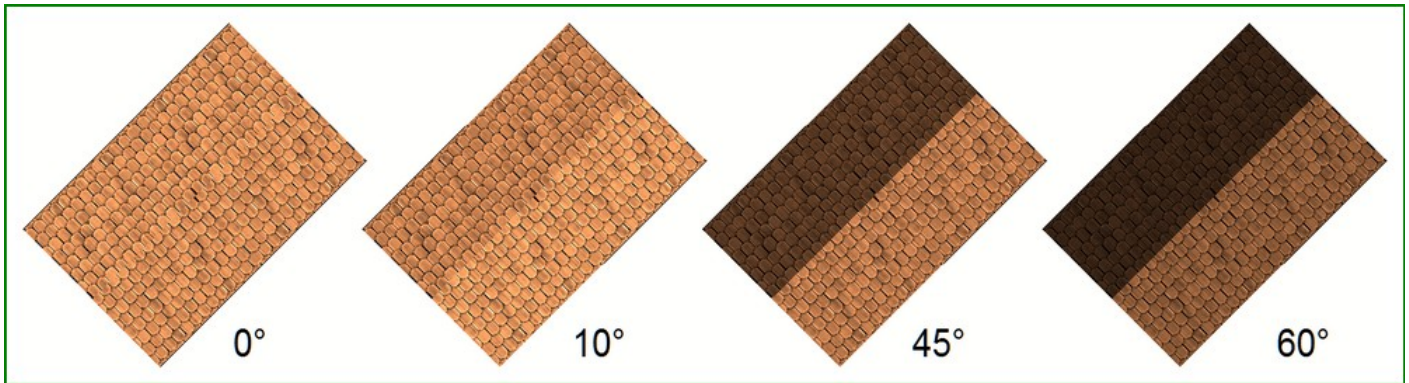

Samples showing the effect of rising pitch angles. The sun settings are CC3 default: azimuth 315° and elevation 60°.

What the shaded polygon **does not** take in account is the scaling effect the pitch should have on the fill style. If you look at the samples above, the tiles forming the fill style are all the at the same size regardless of the pitch angle. This is not realistic as trigonometry teaches us that the higher the pitch angle, the smaller the tiles should look from above, horizontally projected, along the direction of the slope:

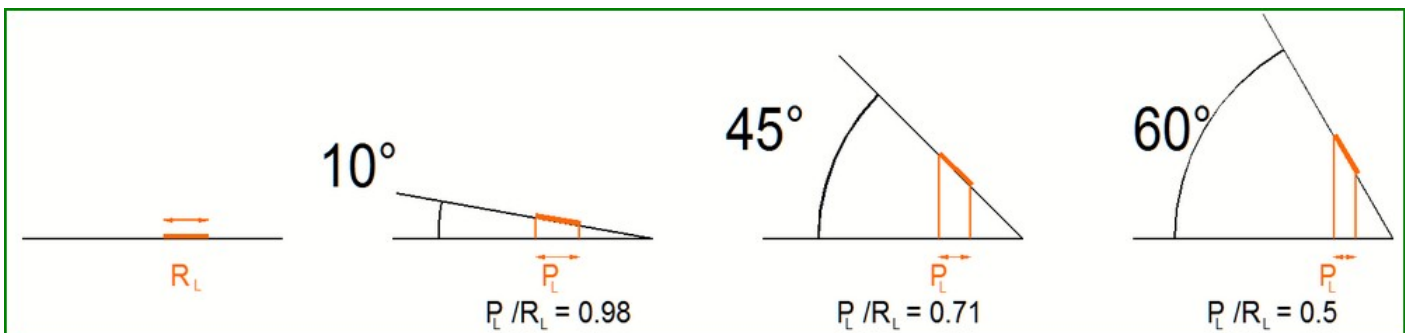

Ratio between the projected length  $P_L$  and the real length  $R_L$  of a tile at various pitch angles. The exact value of this ratio is the cosine of the pitch angle:  $\frac{P_L}{R_L} = \cos(\text{pitch})$

City Designer 3 uses fill styles that already take this scaling in account. The way the styles are designed make them suitable to average pitch angles, and at the scale of a usual town or city, who would check if the tiles of the sharp sloped bell tower are smaller than the tiles of the standard houses?

If you're working at a higher scale, or found a nice texture elsewhere, you might want to modify this behavior. Compare the following picture to the one at the top of this page:

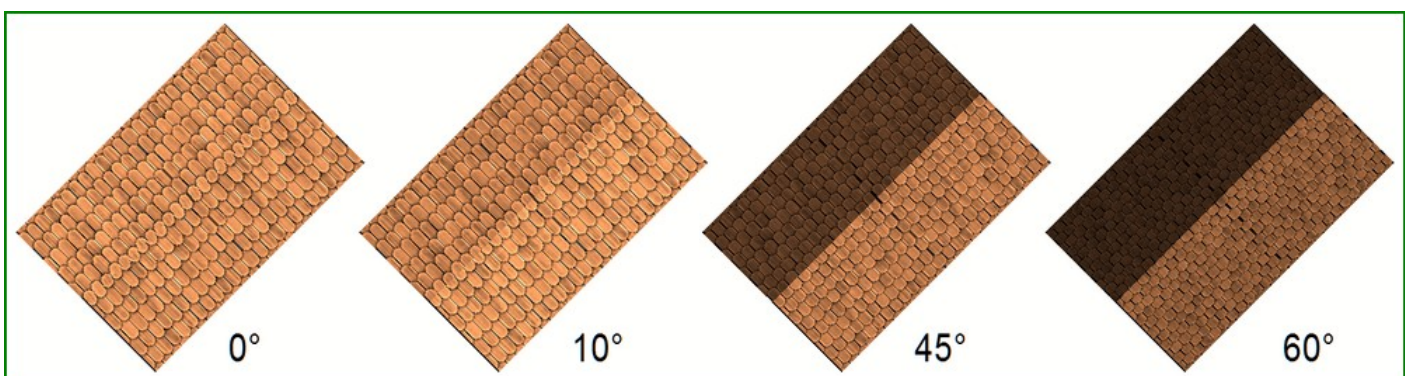

Changing the scale along the slope makes the shaded polygons even more realistic.







The following example shows you how to use Cartographer's Annual 96 (December 2014) roof fill styles that were designed to fill diorama roofs and therefore have a ratio of 1:1.

1. Check that the current sheet is the right one for roofs, that the line width is set to 0, that the line style is set to **solid** or make appropriate modification to your setting. The fill style is not important yet. You can set it to **solid** to better identify the shapes or leave it in its current state. The color can be whatever you want as long as it's not the color of the background.
2. Click on the **Polygon** icon  tool and draw the roof elements. Optionally change the color if you have solid filled entities to better identify them. The sample map features an "L" shaped house. If possible, it's easier to design the walls horizontally and vertically, and rotate the whole house after completion. If not, you'll have to determinate the angles yourself (see sidebar next page).

**NOTE:** If you're using CC3+, it might be easier to add a "User" sub-folder to:  
 C:\Program Data\Profantasy\CC3Plus\Bitmap\ (or equivalent location on your computer)  
 and place the bitmap fill of the roof texture there. The texture used here has been copied from:  
 C:\Program files\Profantasy\CC3\Bitmaps\Tiles\Diorama\KROM Diorama\Roof3 0 VH.png  
 to the CC3+ user sub-folder.  
 Once the Cartographer Annuals are CC3+ compatible this won't be necessary though textures found elsewhere or home-brewed should be treated like this.

3. Choose the pitch angle of your roofs and compute the projection scaling factor which is equal to the cosine of this angle (see previous page). CC3/CC3+ can compute it for you. If you want a pitch angle of 50°, type the following (end each line by hitting "Enter" key):
  - GCOS
  - COSINE
  - 50
  - COSINE

<b>Alternatively use or adapt the following table:</b>											
Angle	10°	20°	25°	30°	40°	45°	50°	60°	70°	75°	80°
<b>Cosine</b>	.98	.94	.91	.87	.77	.71	.64	.50	.34	.26	.17

You will get an error message containing the computed value, here about 0.64279.

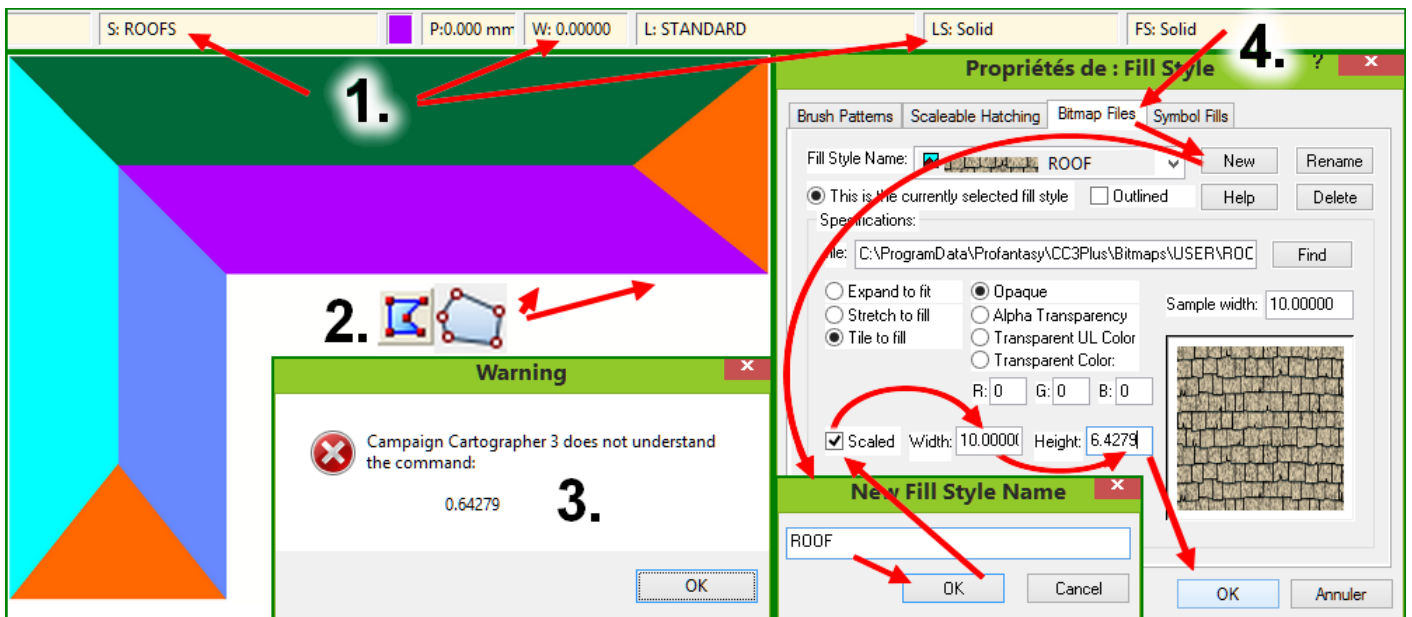

4. Click on the **Fill Style Indicator**, on the **Bitmap Fill** tab then on the **New** button. Name the fill style "ROOF" or any other name you find appropriate. Click **OK**. Check the **Scale** check box and set the width to value adapted to the picture (here 10) and set the height to this same value multiplied by the factor from 3. (here  $10 \times 0.64279 = 6.4279$ ). Verify that the radio buttons are set as displayed bellow or make the necessary changes. Click **OK**.



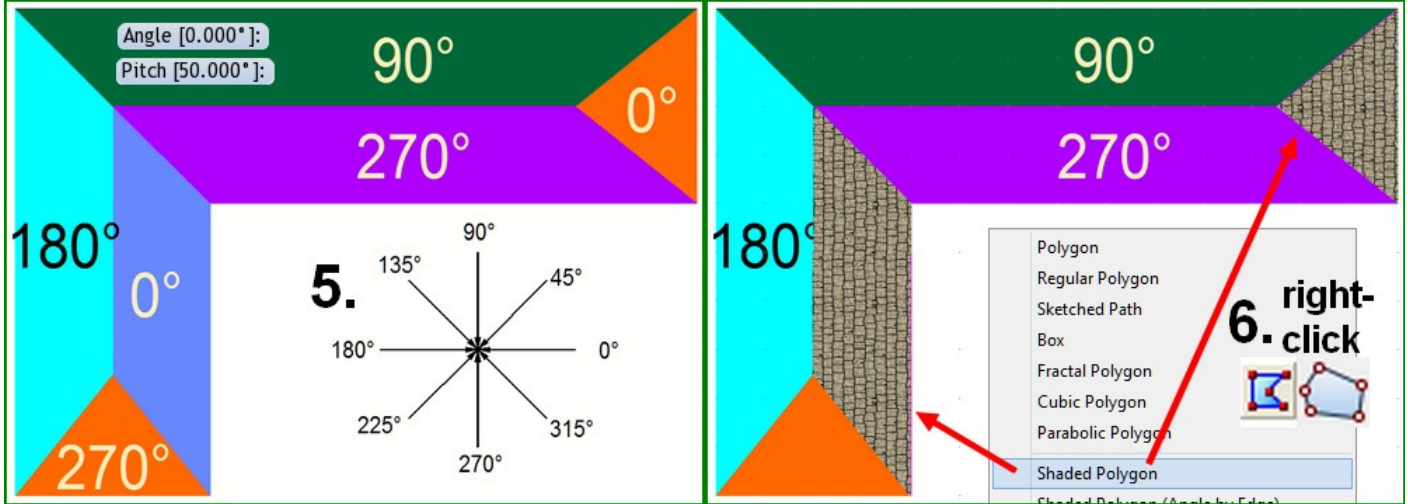

5. Use the angle rose, duplicated here from page 3 for convenience, to assign the shaded polygon angle to each polygon.
6. Right-click on the **Polygon** icon  and choose **Shaded Polygon**. Select all the 0° polygons, right-click **do it**. When the prompt asks for the **Angle**, answer 0. When it asks for the **Pitch**, answer you chosen pitch angle (50 for the sample map).



7. Repeat step 6. for all the different angles. When the prompt again asks for the **Pitch** you can hit the “Enter” key or right-click to validate the default value from step 6.
8. Probably due to rounding or other reasons, you might experience unwanted artefacts like odd pixels or small gaps between the polygons. Back the roofs with a solid black polygon: set the color to 0 and click on the **Fill Style Indicator**, **Brush pattern** tab to set the fill style to **solid**.
9. Click on the **Polygon** icon  and create a polygon following the low edges of the roofs with the help of the **Endpoint modifier** . Right-click to end then click on the **Send to Back** icon , right-click **prior**, right-click **do it** (or hit the “p” for **prior** and “d” for **do it** keys).

### Shaded polygons with odd angles

Sometimes following the horizontal and vertical lines is not an option while creating roofs or other sloped polygons that may require shading.

When you right-click on the **Polygon** icon  you can also see a **Shaded Polygon (Angle by edge)** tool. This tool allows to define a shaded polygon by selecting the target polygon by clicking on the side corresponding to the horizontal lower edge of the slope.

This version does not take the current fill style to create the shaded polygon so you'll have to set it prior to the tool or after making it by using the **Change Properties** tool .

When the shape you're designing doesn't have any horizontal lower edge, you can, as last resort, draw a line from the top of the slope to the bottom then perform a **Info→LIST** command on this line. The **bearing** parameter gives you the **angle** you need.





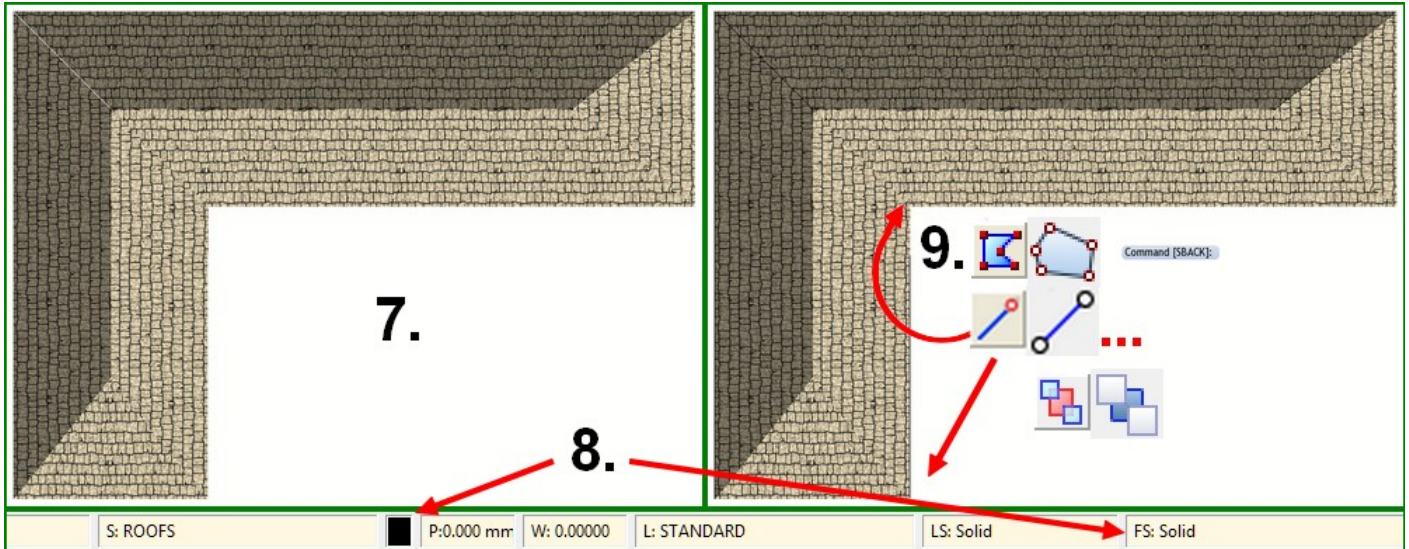

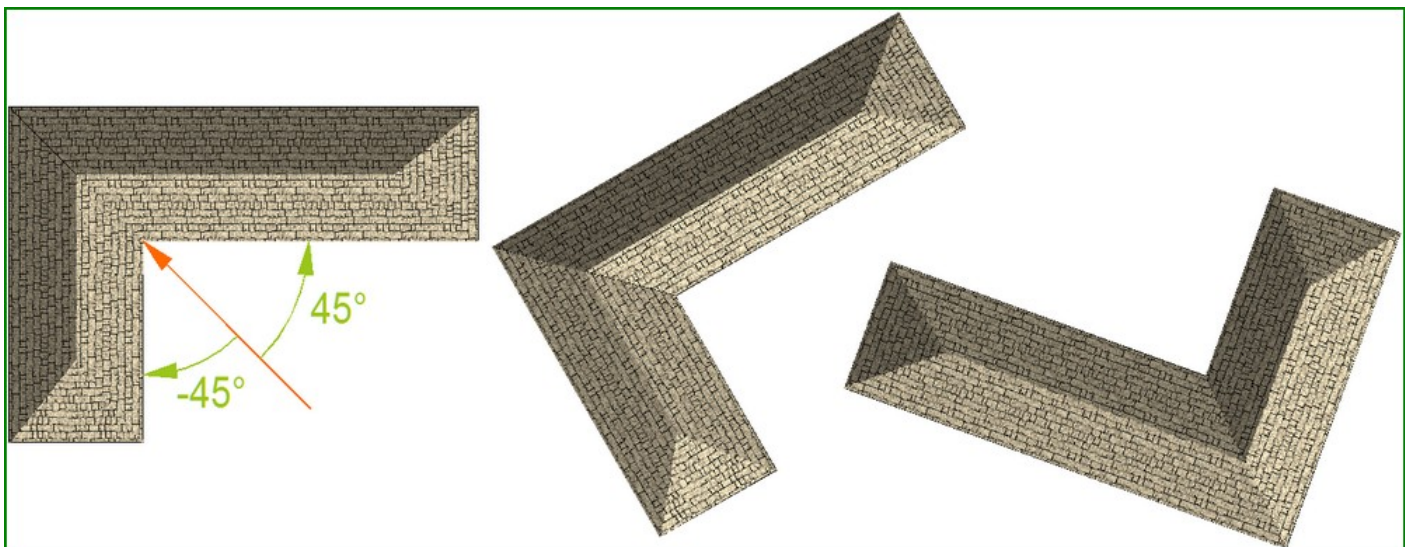

10. Use the rotate tool to rotate the whole house: the shading changes according to the new directions.



Rotated copies of the house. The levels of shadings adapts automatically. Note that if two roof sides make opposite angles with the azimuth (like 45° and -45° on the leftmost house), you'll get the same level of shading on both sides.

11. If you change the **Global sun** (right-click either on the **Sheet and effects** icon  or the **Display Speed Settings** icon  or use the keyboard shortcut **SUNINFO**, see page 3) the shading levels will also adapt automatically:

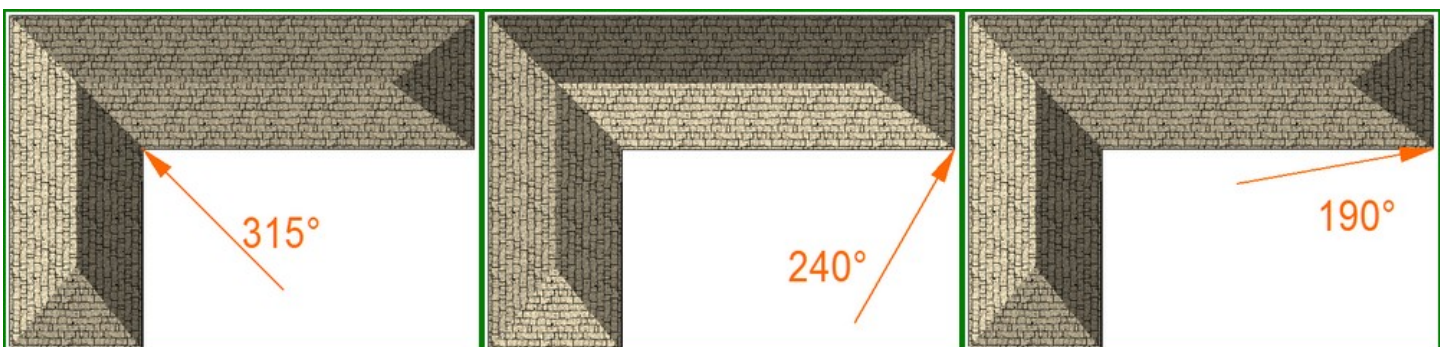



Changing the azimuth automatically changes the shading levels accordingly. Inclination = 60°.



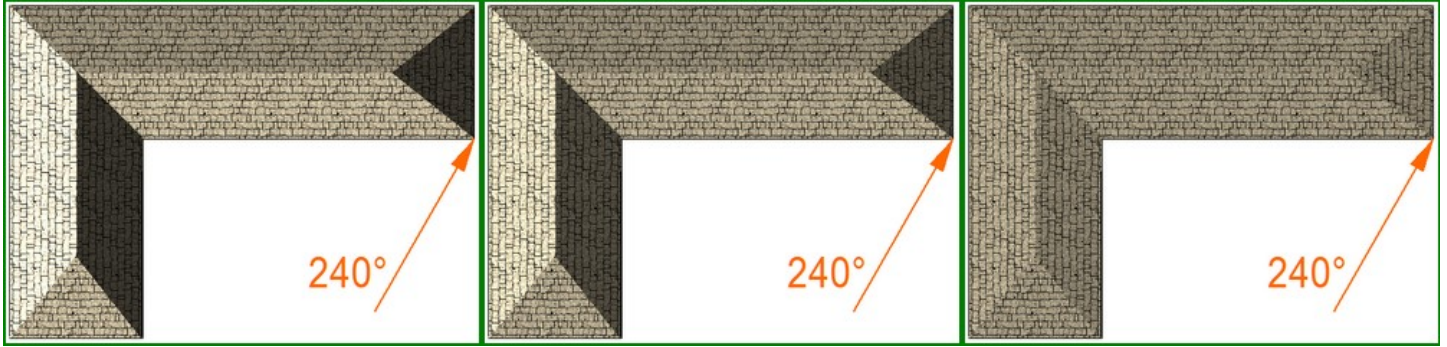



Changing the sun inclination also changes the shading levels accordingly. From left to right: Inclination = 10°, 45° and 80°. Azimuth = 240°.

**Important:** once you've turned a polygon into a shaded polygon, you can't edit its shape (the **Node Edit** tool  is not functional). To edit the shape, you need to first **Explode**  it to revert to a classic polygon, edit, turn it into a shaded polygon again.

Sloped polygons are not limited to roofs. You can use them to add the sloped walls of a fireplace, a ramp, the incline (glacis) of fortifications...

## 2. Shaded polygons to rotate a fill style

The fact that shaded polygons don't alter the scale of a fill style can be useful to rotate this fill style to accommodate a rotated shape.

If you add a wooden platform to the house from part one, and now rotate this house, the roof fill styles will rotate to adapt because they are made of shaded polygon – and of course, the shading adapts too, as seen above. The wooden platform's fill style doesn't rotate though:

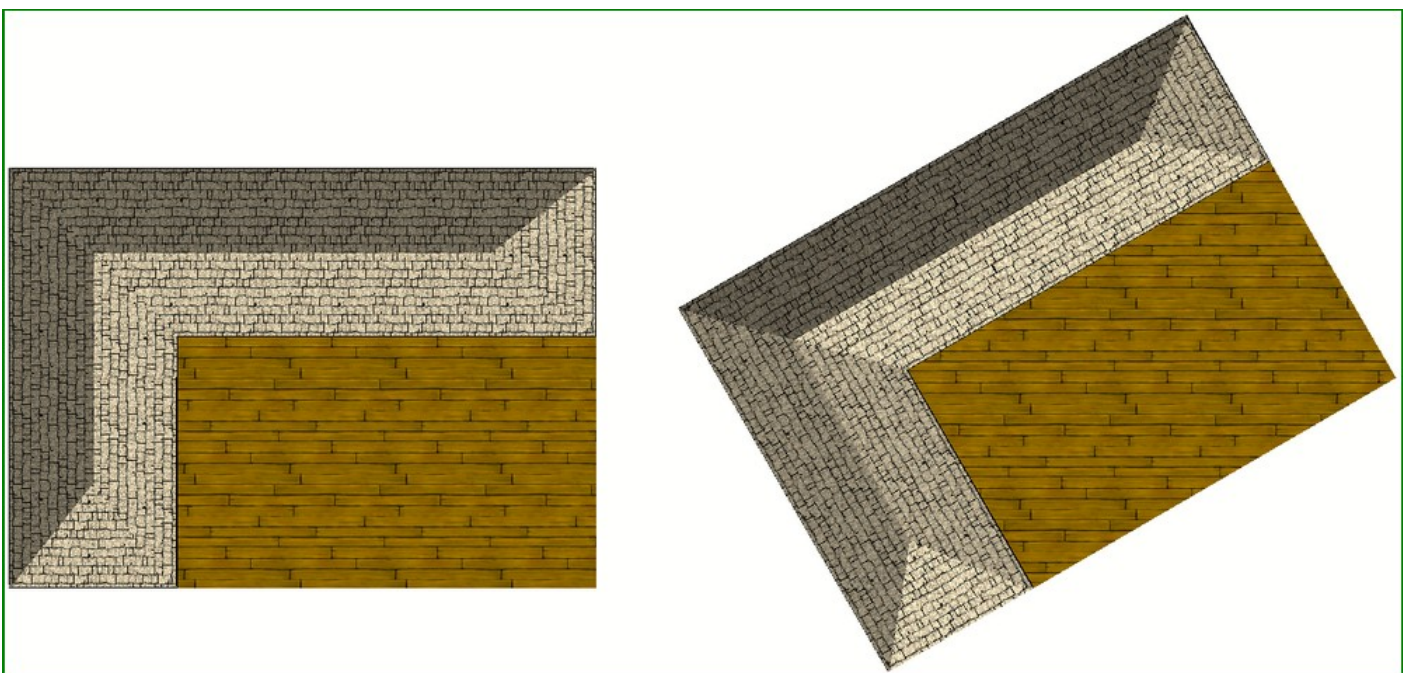





The solution is – of course – to turn the platform in a shaded polygon. This also changes the color of the wood as shading occurs:

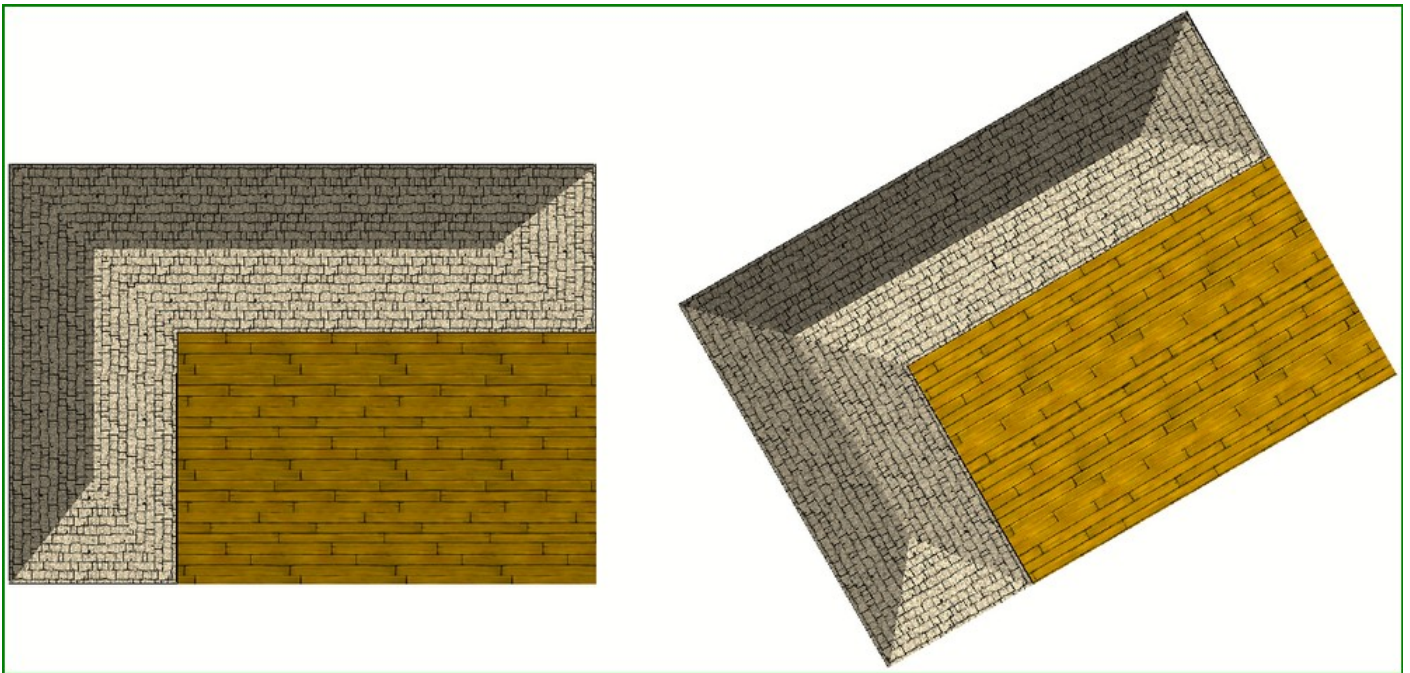

In most situation it won't be so bad as you just have to pretend the wood is lighter or darker.

But what about a map where you would need multiple instances of the same fill style with various rotations angles?

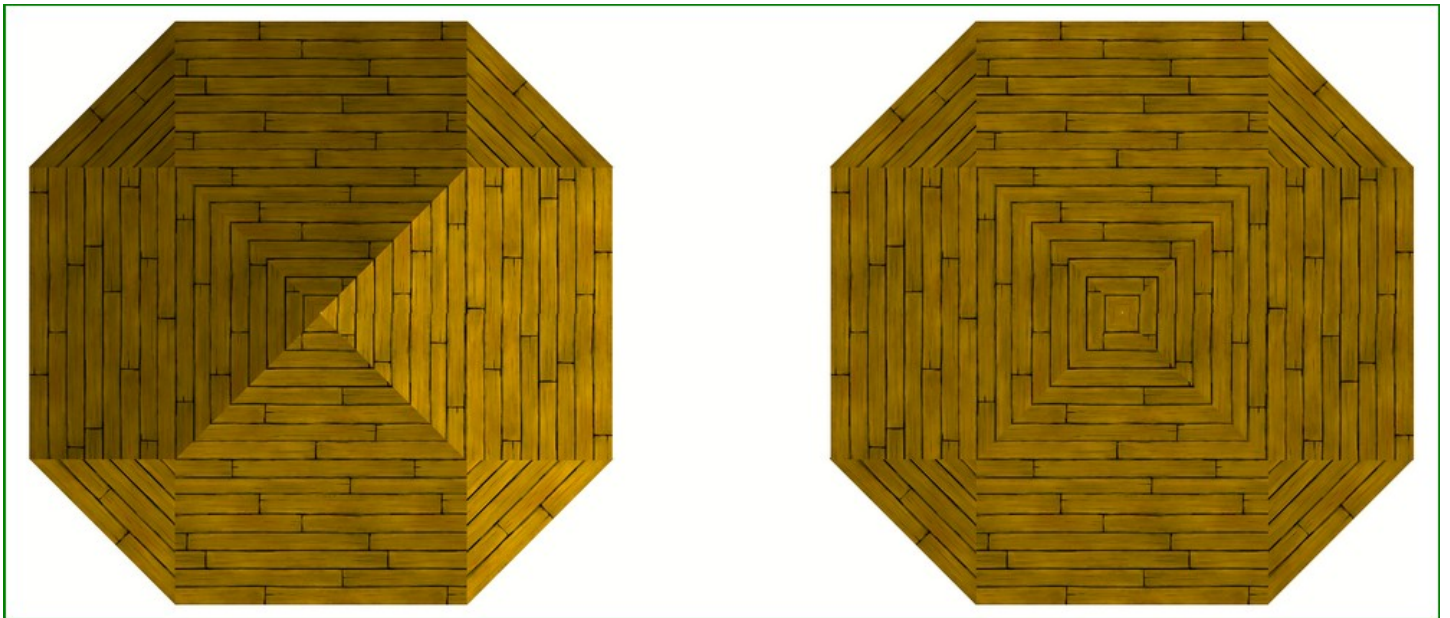

Left: this looks like a roof because the rotated fill styles are lighter or darker than the original fill style (the horizontal planks, mid-bottom). Right: this looks like a wooden floor because all the rotated fill styles have the same shade.

The trick is to play with the pitch: the higher the pitch, the darker the shading polygons. Conveniently, there is a **Change shade pitch** command you can get by right-clicking on the **Polygon** icon .





To get the right color shading, change the pitch by trial and error. The following table has been empirically filled for the default CC3 **Global sun** (azimuth 135°, elevation 60°). It's not too accurate but can give you a good start.

<b>Angle (°)</b>	<b>0</b>	<b>5</b>	<b>10</b>	<b>15</b>	<b>20</b>	<b>25</b>	<b>30</b>	<b>35</b>	<b>40</b>	<b>45</b>	<b>50</b>	<b>55</b>
<b>Pitch (°)</b>	<b>56.5</b>	<b>56</b>	<b>54.5</b>	<b>54</b>	<b>52.5</b>	<b>51</b>	<b>49.5</b>	<b>48.5</b>	<b>46.5</b>	<b>45</b>	<b>44</b>	<b>42.5</b>

<b>Angle (°)</b>	<b>60</b>	<b>65</b>	<b>70</b>	<b>75</b>	<b>80</b>	<b>85</b>	<b>90</b>	<b>95</b>	<b>100</b>	<b>105</b>	<b>110</b>	<b>115</b>
<b>Pitch (°)</b>	<b>41</b>	<b>39.5</b>	<b>38</b>	<b>37</b>	<b>35.5</b>	<b>34.5</b>	<b>34</b>	<b>33</b>	<b>32</b>	<b>31</b>	<b>30.5</b>	<b>30</b>

<b>Angle (°)</b>	<b>120</b>	<b>125</b>	<b>130</b>	<b>135</b>	<b>140</b>	<b>145</b>	<b>150</b>	<b>155</b>	<b>160</b>	<b>165</b>	<b>170</b>	<b>175</b>
<b>Pitch (°)</b>	<b>30</b>	<b>29.5</b>	<b>29</b>	<b>29</b>	<b>29</b>	<b>29.5</b>	<b>30</b>	<b>30</b>	<b>30.5</b>	<b>31</b>	<b>32</b>	<b>33</b>

<b>Angle (°)</b>	<b>180</b>	<b>185</b>	<b>190</b>	<b>195</b>	<b>200</b>	<b>205</b>	<b>210</b>	<b>215</b>	<b>220</b>	<b>225</b>	<b>230</b>	<b>235</b>
<b>Pitch (°)</b>	<b>34</b>	<b>34.5</b>	<b>35.5</b>	<b>37</b>	<b>38</b>	<b>39.5</b>	<b>41</b>	<b>42.5</b>	<b>44</b>	<b>45</b>	<b>46.5</b>	<b>48.5</b>

<b>Angle (°)</b>	<b>240</b>	<b>245</b>	<b>250</b>	<b>255</b>	<b>260</b>	<b>265</b>	<b>270</b>	<b>275</b>	<b>280</b>	<b>285</b>	<b>290</b>	<b>295</b>
<b>Pitch (°)</b>	<b>49.5</b>	<b>51</b>	<b>52.5</b>	<b>54</b>	<b>54.5</b>	<b>56</b>	<b>56.5</b>	<b>57</b>	<b>58</b>	<b>59</b>	<b>59.5</b>	<b>59.5</b>

<b>Angle (°)</b>	<b>300</b>	<b>305</b>	<b>310</b>	<b>315</b>	<b>320</b>	<b>325</b>	<b>330</b>	<b>335</b>	<b>340</b>	<b>345</b>	<b>350</b>	<b>355</b>
<b>Pitch (°)</b>	<b>60</b>	<b>60</b>	<b>60</b>	<b>60</b>	<b>60</b>	<b>60</b>	<b>60</b>	<b>59.5</b>	<b>59.5</b>	<b>59</b>	<b>58</b>	<b>57</b>

Rotated fill styles can also be used in CC3 Diorama to create pyramidal shapes, like an almost conical roof or an Egyptian pyramid:

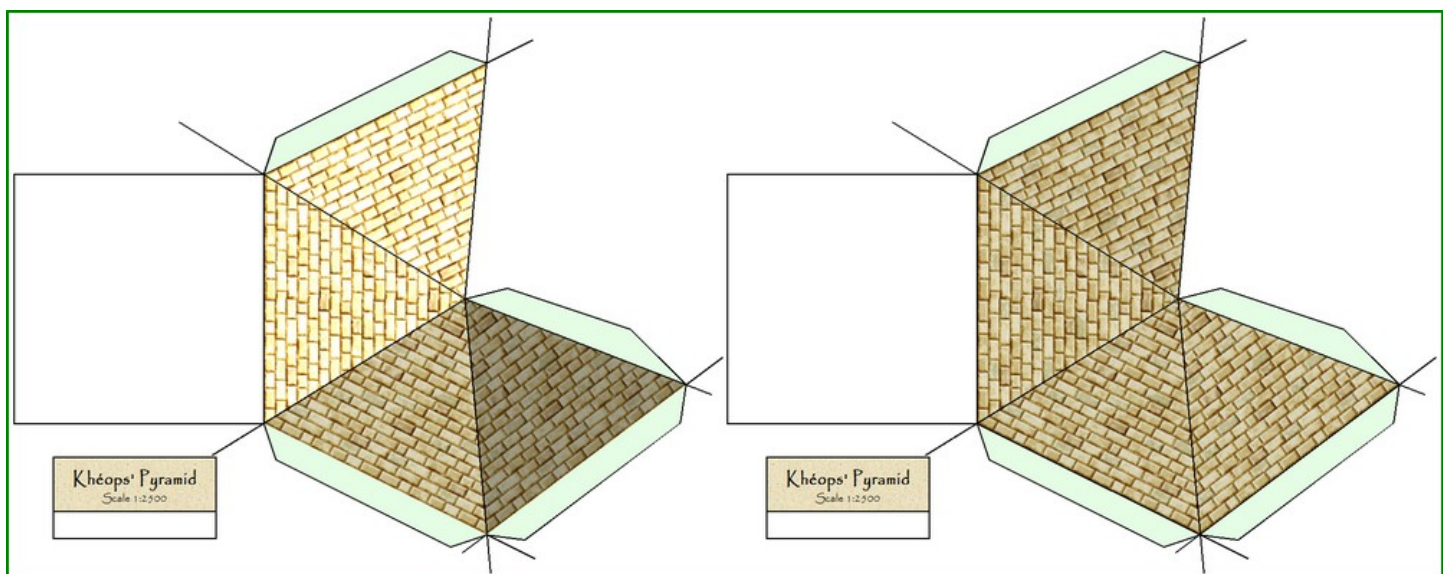

Left: no pitch adjustment. Right: pitch changed according to the previous table.







### 3. Shaded polygons and top down perspective

This uses shaded polygons with no pitch adjustment and distorted fill styles as mentioned on page 4 of this article.

The steps used to create such a top down perspective has already been treated in a [separate tutorial](#).

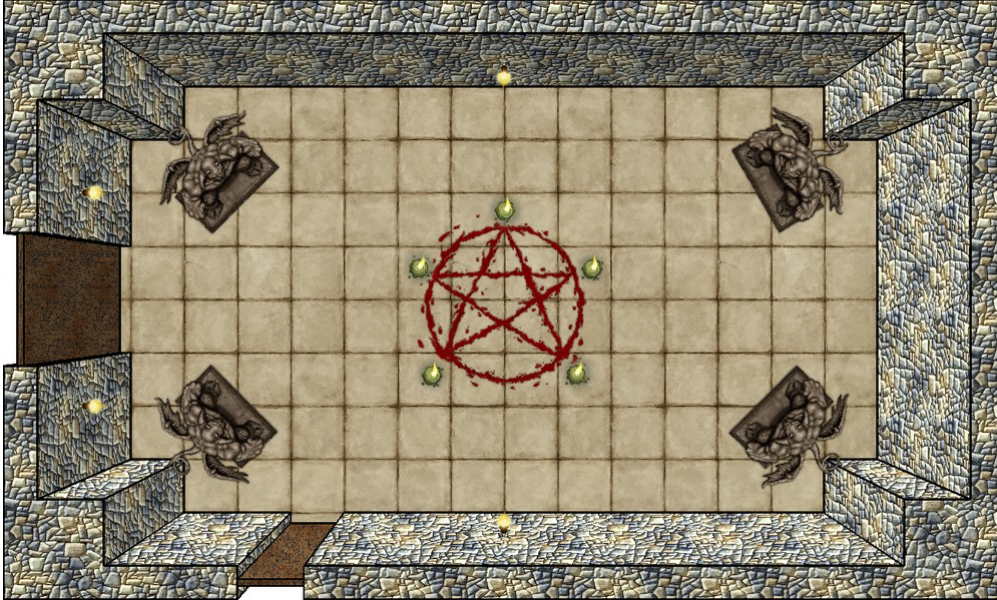

The dungeon room detailed in the top down perspective article.

## Conclusion

Shaded polygons are used to create nice roofs or slopes in CD3 but can also be used to rotate fill style, tweaking their pitches to keep the fill style in the same hues. Furthermore, shaded polygons can be used to create top down perspectives.

If you enjoyed this article, or have other ideas about shaded polygons, please leave your feedback [here](#).

Other articles available:

[Hanin's Chapel](#): a tutorial to design a dungeon battle map from scratch.

[Map Bits as Fill Styles](#): how to use exported parts in a dungeon map.

[False Spirals](#): how to create and use them.

[Light Effects](#): an article to reach enlightenment.

[CC3 and Perspective](#): a tutorial to create a top down view of a room.

[Multiple use of Multipolys](#): an article on... multipolys...



Happy mapping!  
Joachim de Ravenbel  
April 2015 – January 2017

